

# Data Sheet

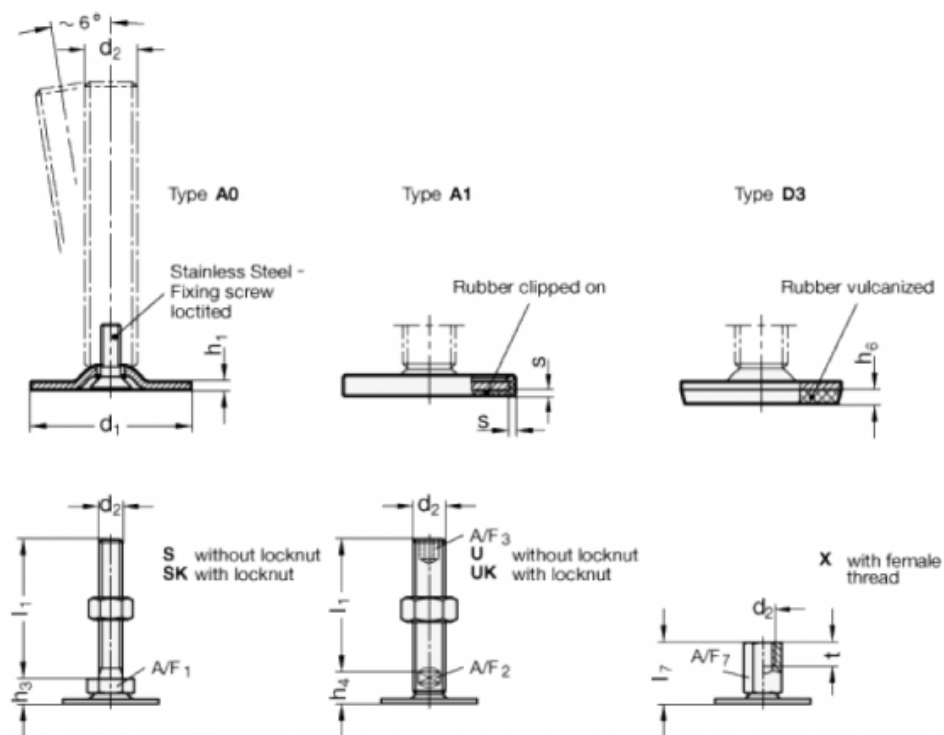

Article number: 204080M10100A0SK  
 Description: E+G levelling foot  
 GN 40-80-M10-100-A0-SK  
 Note: SK With nut, External hexagon at the bottom

## Measures



- A/F1 = 17
- d1 = 80
- d2 = M10
- h1 = 3
- h3 = 12
- h6 =
- l1 = 100
- s =